

REDSKAN mini-Pro

Advanced LiDAR sensors for indoor/ outdoor high-security applications



RLS-2020A

20m x 20m (65 x 65 ft.) LiDAR

RLS-2020V

20m x 20m (65 x 65 ft.) LiDAR
with built-in FHD camera





Extremely accurate intrusion detection sensors using time-of-flight technology to identify the size, location and distance of moving or loitering objects and track them to the exact X and Y coordinates. Now with built-in camera for verification and recording.



ONVIF | S



REDFSCAN mini-Pro detects threats proactively with pinpoint accuracy not affected by variable lighting, temperature or weather conditions.

-  X / Y Coordinate Information
-  Detection Target Size
-  Detection Area Information
-  Privacy-compliant solution by collecting only anonymized 2D data
-  Optional built-in camera for visual verification and recording

Key Applications:

- Valuable assets and restricted areas
- Rooftops and skylights
- Glass façades
- Perimeters and gates
- Narrow corridors
- Under floor and ceiling
- Tunnel and rail crossings

Key Features

Intelligent analytics

REDFSCAN mini-Pro uses LiDAR technology to accurately detect even in complete darkness and harsh complex environments. Wherever the target or targets are within the detection area they will be detected and visualized instantly at 100msec with angular resolution of 0.125 degrees.

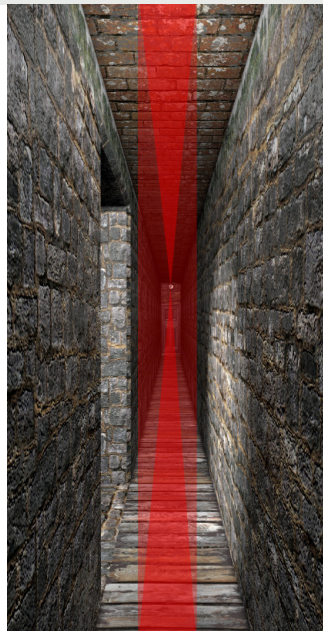

Customisable detection areas

REDFSCAN mini-Pro allows flexible mounting options providing a high resolution 20m x 20m horizontal, vertical or angled detection area.

It allows to create up to 8 independent detection zones and set the detection parameters according to the installation environment and the target object.



Suitable for every environment

REDFSCAN mini-Pro features auto adjustment area to adapt to the ground level and environmental resistance function to provide

effective detection even in the harshest weather conditions. It can operate from -20 (or -40 with heated lens) to +60 degrees.



Dynamic event filtering

Real-time analysis and filtering of events based on a certain logic help security teams be more efficient and prioritise their response to the

most critical incidents. For instance, to alert if the target is walking in a certain direction or if a security guard is absent from the detection area.

Verify alarms with built in camera and IR LED

REDSCAN mini-Pro RLS-2020V model has a built-in FHD camera to help with verification when an alarm signal is generated. The camera covers the full detection area and is equipped with IR LED with adjustable luminance strength so the visualization of the detection target is clear even at nighttime or in badly illuminated areas.

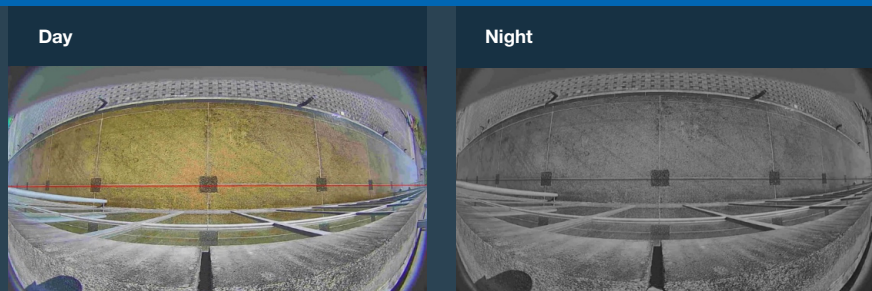

Onboard recording

Pre- and post-alarm detection data and camera images are saved in the internal memory, with a high-capacity for storage of up to 500 events.

Connectivity for easier integration in the security system

REDSCAN mini-Pro is ONVIF Profile S compliant allowing it to send alarm outputs to any compliant networked video system or IP devices.

Compliant with popular network protocols like DNS, DHCP, NTP, Ws-Discovery.

Dynamic map live streaming

Photos and map images can be used to overlap the detection area for better situational awareness. Either “Scan area” or “object position” can be sent to ONVIF compliant software/devices when an alarm occurs.



Enhanced security network

REDSCAN mini-Pro provides a secure connection to the network, with a choice of IP connection and analogue connection.

Equipped with leading industry protection, it effectively prevents from potential hacking threats.

Compliant with:
HTTPS, SNMPv3, IEEE802.1X.

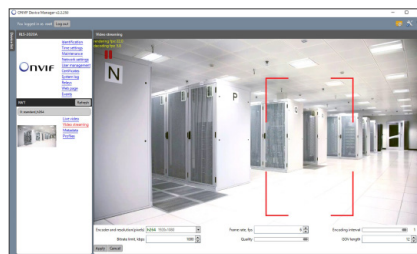

Easy Installation and configuration

Multi-angle adjustment shell

Easily re-configure the unit and adjust it to the mounting conditions.

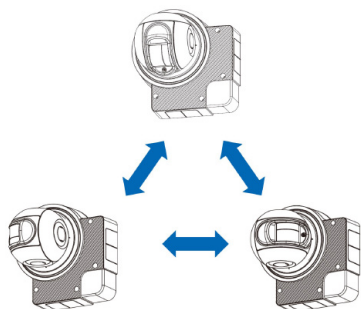

Intuitive user interface

Settings are done via web browser for easy and flexible configuration and maintenance.

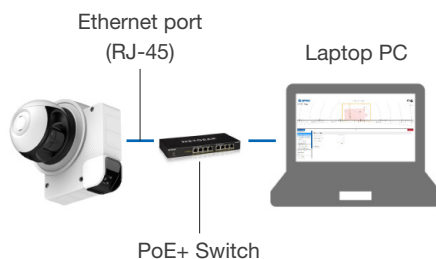

Visualization of detection area

A laser guideline and the visualization of the scene help the sensor's alignment

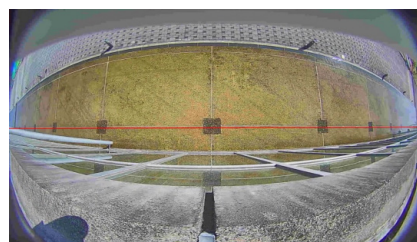

Detection range

20 x 20 m (Approx. 65 x 65 ft.), 95 degrees

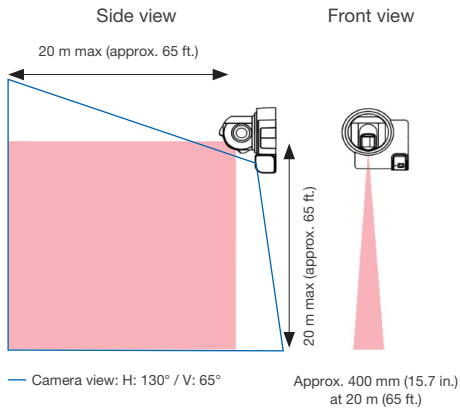

Detection range in extended mode

30 x 30 m (Approx. 65 x 65 ft.), 95 degrees

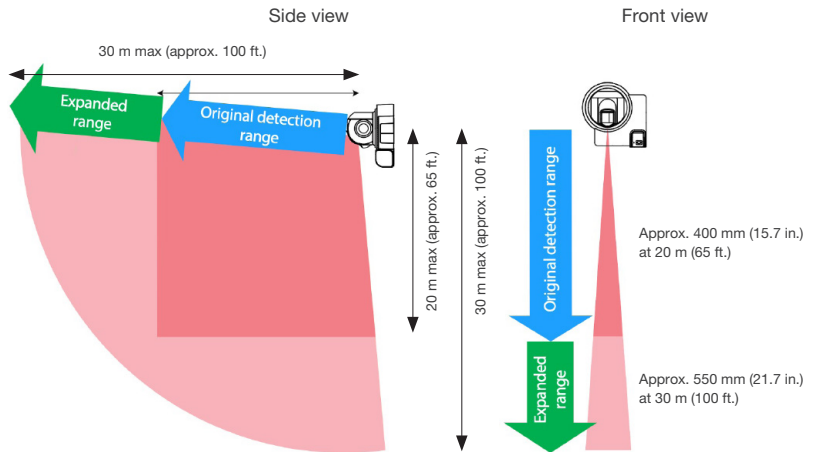

Specifications

Model	RLS-2020V	RLS-2020A
Installation location	Indoor/Outdoor	
Detection method	Infrared Laser Scan	
Laser protection class	Class 1	
Power input	19.2-30 VDC, PoE+ (IEEE 802.3 af/at compliant)	19.2-30 VDC, PoE (IEEE 802.3 at compliant)
Current draw	580 mA max. (24 VDC), 14 W max. (PoE+)	420 mA max. (24 VDC), 10 W max. (PoE)
Mounting method	Ceiling mount, Wall mount, Pole mount	
Detection area	20 x 20m, 95 degree (approx. 65 x 65 ft.)	
Detection range	Radius 1 to 21 m (approx. 3.3 to 68 ft.) at 10% reflectivity	
Detection resolution / Response time	0.125 degrees / within 100 msec. to 15 min. / 0.25 degrees / within 50 msec. to 15 min.	
Mounting height (Vertical mode)	Indoor: 2 m (6.7 ft.) or higher / Outdoor: 4 m (13 ft.) or higher (Recommended)	
Communication port	Ethernet RJ-45 10BASE-T/100BASE-TX (Auto negotiation)	
Protocol	UDP/ TCP/ HTTP/ HTTPS/ IPV4/ IPV6/ DNS/DHCP/ SNMPv1-v3/ NTP/ WS-Discovery/ ONVIF/IEEE802.1X	
Output	6 outputs, 28 VDC 0.2 A max. N.O./N.C.(selectable) 6 from Master alarm, Zone alarm, Trouble, Tamper, Environmental Disqualification, Device Monitoring) (programmable) RS-485	
Input	2 Non-voltage contact input (Detection profile switching, Area set, Sensor check) (programmable)	
Alarm period	Approx. 2 second delay timer	
Operating temperature	-40°C to 60°C (-40°F to 140°F)	
Dimensions (H×W×D) Weight	202.6 x 206.7 x 163.5 mm max. (8.0 × 8.1 × 6.4 inch)	
IP rating	IP66	

Dimensions

Unit: mm (inch)

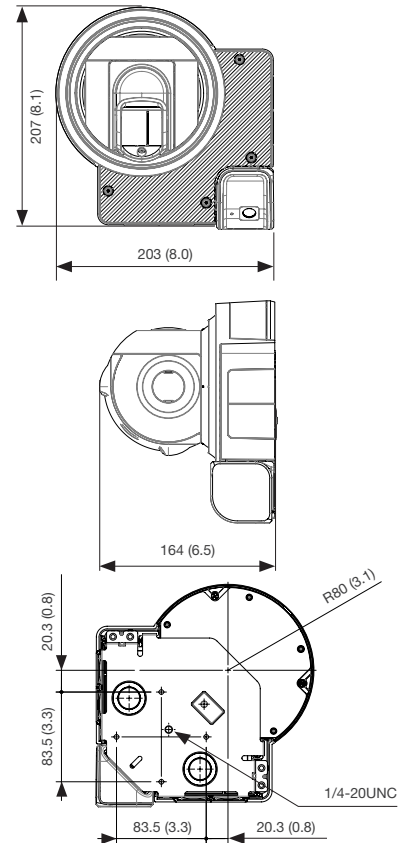

Camera specifications

Model	RLS-2020V
Image sensor	Full HD (1980 x 1080)
Image resolution	1080P (Web User Interface) / 1080P/720P/360P (RTSP)
Viewing angle	H: 130° / V: 65°
Minimum illumination	Approx. 1 lux.
Day and night	Removable infrared-cut filter (Auto / Night / Day) (selectable)
Image compression	H.264, JPEG
Frame rate	1 to 10 FPS (selectable)

Accessories

LAC-1	RLS-LW	RLS-PB
Laser Area Checker for all RLS series	Laser window for replacement	Pole mount Bracket



OPTEX CO., LTD. (JAPAN)
www.optex.co.jp/e

OPTEX EMEA Security Headquarters
OPTEX EUROPE LTD (UK and Africa)
OPTEX Security B.V. (EU)
OPTEX Dubai Branch (Middle East)
W: www.optex-europe.com
E: marketing@optex-europe.com

OPTEX SECURITY SAS
(France, French speaking North and West African countries)
W: www.optex-europe.com/fr
E: contact@optex-security.com

OPTEX SECURITY Sp.z o.o.
(Eastern Europe, Turkey)
W: www.optex-europe.com/pl
E: optex@optex.com.pl