

# DHI-KTX01(F)

## Video Intercom KIT

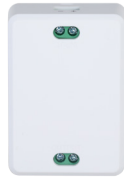

EACH

### Technical Specification

DHI-VTO2003F

#### System

Main Processor	Embedded Processor
Button Type	Mechanical

#### Basic

Camera	1/2.8" 2 MP CMOS HDR Camera
Field of View	H: 110°; V: 60°
WDR	DWDR
Noise Reduction	3D NR
Video Resolution	P: 960 (H) × 576 (V) N: 960 (H) × 480 (V)
Video Frame Rate	P: 25 fps N: 30 fps
Light Compensation	Auto IR
Day/Night	Auto(ICR)/Color/B/W
Audio Input	1
Audio Output	Built-in speaker
Audio Mode	Two-way audio (half-duplex)

#### Function

Unlock Mode	Remote unlock
Leave Videos	Yes (SD card inserted in VTH is needed)

### 2-wire Wi-Fi Hybrid Indoor Monitor:

- 7" TFT capacitive touch screen.
- Offers video intercom that communicates with VTOs through half-duplex, and the app through full-duplex.
- Supports recording videos and capturing snapshots. (SD card is required).
- 6-channel alarm input and 1-channel alarm output.
- The app can be used to receive calls and alarm notifications.
- Connects to HDCVI camera.

### 2-wire Hybrid Villa Door Station:

- Aluminum alloy front panel.
- Auto IR illumination.
- Video messages can be left for unanswered calls. (SD card is required for VTH).
- Features nameplate and DWDR.
- Supports local lock and second lock.
- Offers anti-tampering alarm.
- IP65 and IK07 rated.

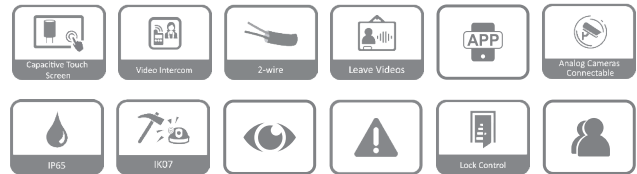

### Performance

Casing Material	Aluminum Alloy
-----------------	----------------

#### Port

RS-485	1
Alarm Output	1
Power Output	1 × 12 VDC output, 200 mA
Exit Button	1
Door Status Detection	1
Lock Control	1

#### Alarm

Tamper Alarm	Yes
--------------	-----

#### General

Appearance Color	Silver
Power Supply	2-wire controller
Installation	Flush Mount

Certifications	CE; FCC
Product Dimensions	130 mm × 96 mm × 28.5 mm (5.12" × 3.78" × 1.12")
Protection	IP65 IK07
Operating Temperature	-40 °C to +60°C (-40 °F to +140 °F)
Operating Humidity	10%–95% (RH), non-condensing
Operating Altitude	0 m–3000 m (0 ft – 9842.52 ft)
Power Consumption	≤ 1.5 W (standby), ≤ 10 W(working)
Gross Weight	0.502 kg (1.11 lb)
Storage Temperature	-40 °C to +70°C (-40 °F to +158 °F)
Storage Humidity	95% (RH), non-condensing

### DHI-VTH5123H-W

#### System

Main Processor	Embedded Processor
Operating System	Embedded operating system
Network Protocol	IPv4; UDP; DNS; TCP

#### Basic

Screen Type	Capacitive Touchscreen
Display Screen	7" TFT
Screen Resolution	1024 (H) × 600 (V)
Audio Compression	G.711a; G.711u; PCM
Audio Input	1
Audio Output	Built-in speaker
Audio Mode	Two-way audio with VTO (half-duplex);Two-way audio with app (full-duplex)
Audio Enhancement	Echo suppression/digital noise reduction
Audio Bit Rate	16 kHz; 16 bit

#### Function

Leave Videos	Yes (SD card needed)
DND Mode	Do not disturb period can be set; Do not disturb mode can be set.
Number of Extensions	5
Wi-Fi	Yes
Wireless Standard	IEEE802.11b/802.11g/802.11n
Wireless Frequency Range	2.4 GHz
Storage	Micro SD card (up to 64 GB)

#### Port

RS-485	1
Alarm Input	6

Alarm Output	1
Power Output	1 (12 V, 200 mA)
Door Bell	Yes (use the alarm input port)

#### Performance

Casing Material	PC + ABS
-----------------	----------

#### General

Appearance Color	White
Power Supply	2-wire controller
Installation	Surface Mount
Certifications	CE; FCC
Product Dimensions	130 mm × 189 mm × 23.9 mm (5.12" × 7.44" × 0.94")
Operating Temperature	-10 °C to +55°C (14 °F to +131 °F)
Operating Humidity	10%–95% (RH)
Operating Altitude	0 m–3000 m (0 ft – 4265.09 ft)
Power Consumption	≤ 2.5 W (standby), ≤ 10 W(working)
Gross Weight	0.633 kg (1.40 lb)
Storage Temperature	-40 °C to +70°C (-40 °F to +158 °F)
Storage Humidity	95% (RH), non-condensing

### VTNC1003C

#### Performance

Casing Material	PC + ABS
-----------------	----------

#### General

Appearance Color	White
Power Supply	48 VDC
Certifications	CE; FCC
Accessory	Included: Line termination terminal
Product Dimensions	65.2 mm × 46.2 mm × 23.2 mm (2.57" × 1.82" × 0.91")
Operating Temperature	-10 °C to +55°C (14 °F to +131 °F)
Operating Humidity	10%–95% (RH)
Operating Altitude	0 m–3000 m (0 ft – 4265.09 ft)
Power Consumption	3.5 W
Gross Weight	0.13 kg (0.29 lb)

**Ordering Information**

Type	Model	Description
Kit	DHI-KTX01(F)	Video Intercom Kit. It includes: DHI-VTO2003F: 2-wire Hybrid Villa Door Station DHI-VTH5123H-W: 2-wire Wi-Fi Hybrid Indoor Monitor VTNC1003C: 2-wire Controller VTM114: Flush Mounted Box 1 x Power Adapter 1 x Power Cord

**Installation (mm[inch])**

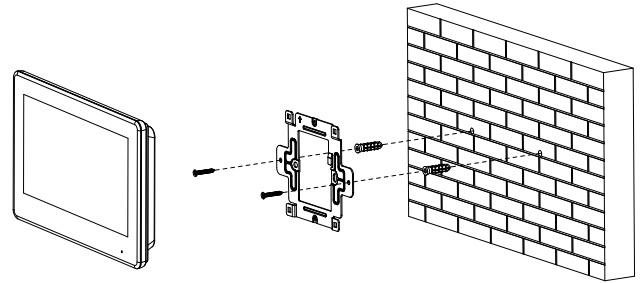

**Relevant Products**



DHI-VTO2003F



DHI-VTH5123H-W

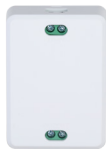

VTNC1003C



VTM114



VTM114

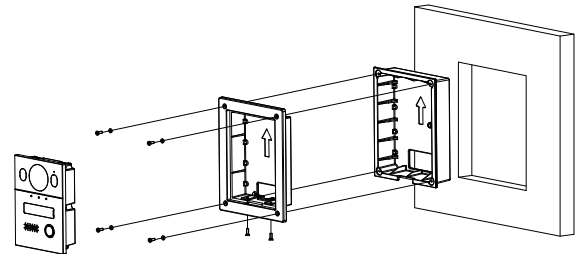
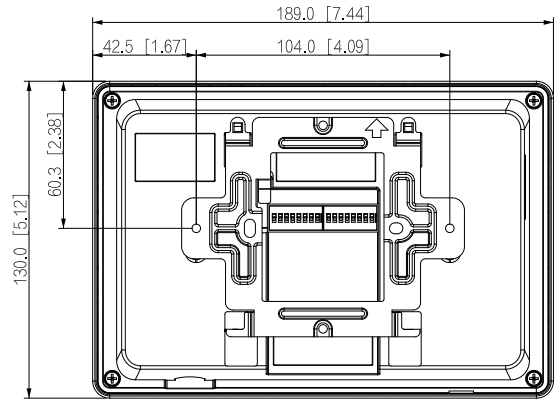

**Dimensions (mm[inch])**

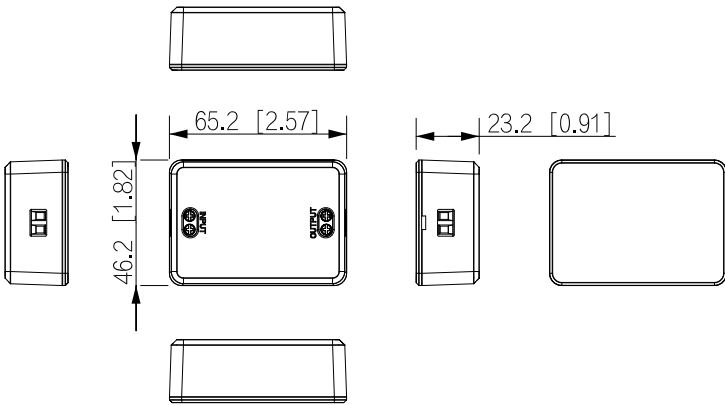
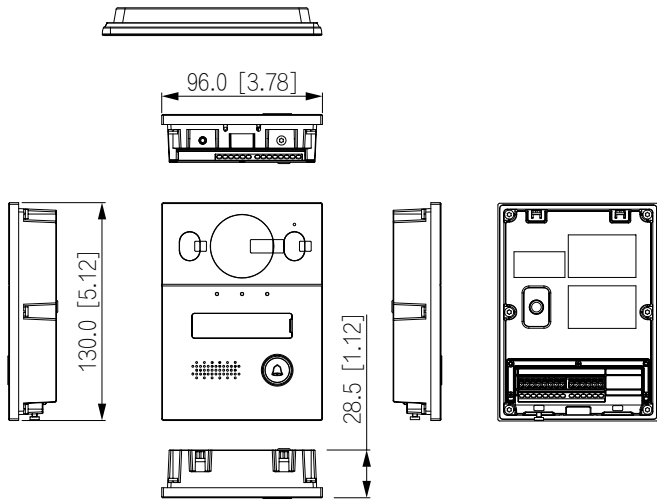
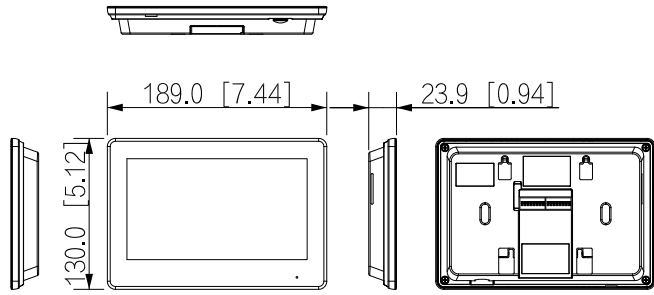

**Application**

